



Rohmann GmbH

Eddy Current Test Instruments and Systems
Product Overview





Imprint (German)

Concept, design, layout © by Rohmann GmbH

Responsible for contents and texts: Rohmann GmbH

Photos: Frank Geldhäuser/ Foto Filling, Steffen Lang, istock, Fotolia, Adobe Stock

Stand: März 2020

Table of Contents

History and presentation	4 - 5
Handheld testers and accessories	6 - 9
Laboratory and line testers	10 - 19
Test Systems	20 - 29
Test probes and accessories	30 - 35
Rotors	36 - 39
Software	40 - 41
Customer Test Systems	42 - 48



History

ROTOTEST

the specialist for hole inspection

The ROTOTEST line was designed especially for fast and safe hole inspections with rotating probes. The instruments are precisely designed for user-friendly application in dynamic testing tasks.



ELOTEST B1

the „Classic“

When it first came on the market, the ELOTEST B1 was the compact, portable, mains-independent and battery operated universal eddy current test instrument. It is the standard worldwide for static and dynamic testing tasks without compromise. Launched in 1985, it was the first microprocessor-controlled, portable eddy current test instrument in the world.



With our classics, the ELOTEST B1 and the Rototest B588, company founder and developer Jürgen Rohmann laid the foundation for the company's success.

ELOTEST IS

the efficient system concept for production

The ELOTEST IS is optimized for automatic testing and evaluation of continuous materials and mass-produced parts. It detects material damage on almost all electrically conductive materials.



ELOTEST PL.E

proven in the production line

The ELOTEST PL.E was a compact universal device for rapid testing in the manufacture of semi-finished products. With 2 test channels, it worked independently or in conjunction with host computers, PC or PLC.



The Rohmann GmbH stands for quality and innovation since 1977

Rohmann GmbH is a leading manufacturer of eddy current testing equipment and systems for non-destructive materials testing (NDT).

Since decades, our family-owned company based in Frankenthal, Germany, has been developing, producing and marketing testing equipment and systems that are used today worldwide in crack, heat treatment, material mix-up and grinding burn testing for well-known companies in the aerospace, automotive and industrial sectors, for railways, in the energy sector (power plants, renewable energies) and in the steel industry.

We support the constantly increasing quality demands of our customers with a comprehensive range of hand-held

devices, line devices, robot-controlled testing systems and suitable software solutions for documentation. Our goal is the continuous development of modern, innovative and new products for different areas is our goal.

Thus we continue the visions of the developer Jürgen Rohmann. Together with his wife Ines Rohmann, he founded Rohmann GmbH in 1977 as a two-man company, which today is managed by Petra Rohmann in the second generation.

His vision was to produce systems that provide the highest performance and test reliability.

We are proud to be able to continue his successful work with a committed team.



Jürgen Rohmann in 1959



Company building in Frankenthal

Hand-held eddy current tester



ELOTEST M2 V3

small and light

The ELOTEST M2 V3 is a universal eddy current tester for surfaces, bores and concealed structures. Due to its low weight, it is designed for real one-hand operation. It measures the conductivity of non-ferromagnetic materials as well as the layer thickness of non-conductive layers on all conductive materials. The dual frequency test with signal mix for the suppression of interference effects can be used in the complete test frequency range from 10 Hz to 12 MHz. It has all filter functions (LP, HP, BP) for signal optimization for static and dynamic tests.

The sharp LCD display with LED illumination on the rear guarantees an presentation display of the test signals. Integrated calibration bodies simplify and accelerate work on site.

With all our test devices, the focus is on user-friendliness: a clearly structured keypad with clear function assignment and plain text messages for a safe test sequence – operable with just one hand!

Weld inspection kit

LAB-10 H-33.06.1
sensor, layer thickness

BAL-1 H-161
weld sensor \varnothing 12 mm

BAL 73-1
weld sensor \varnothing 16 mm

TP 11.02.1

EKB-2-024
sensorcable

TP 168
Fe-weld seam

P-422
Teflonribbon

*Sensors and accessories
for non-destructive
testing of machined and
unmachined weld seams.*

Weld Seam Inspection

crack testing on weld seams even under paint layers

The weld inspection kit was developed for the detection and evaluation of cracks in welds.

Wherever seams – machined or unmachined, through paint layers or on corroded surfaces, on ferritic materials – have to be inspected quickly, reproducibly and cost-effectively, the Weld Seam Inspection Set is the right choice.

In these areas, eddy current testing can be regarded as an alternative to magnetic particle testing or dye penetrant testing.

Very often, paint layers of different thicknesses make testing more difficult. An important part of the inspection task is to evaluate these layer thicknesses and then opti-

mize the seam inspection. The absolute sensor LAB-10 H-33 in the set is ideally suited for this purpose. This sensor is designed as a bridge circuit and can be operated just like the crack detection sensors BAL 73-1 and BAL-1 H-161 with the cable EKB-2-024.

Both the ELOTEST M2 and the ELOTEST M3 can be used as suitable test instruments. Together with the weld test set, the included weld test body TP 168 and the crack plate TP 11.02.1 with calibration foils made of plastic, paint film thicknesses of up to 2 mm can be simulated and calibrated for testing.

The test with the weld seam test set meets the requirements of DIN EN 1711.

Hand-held eddy current tester

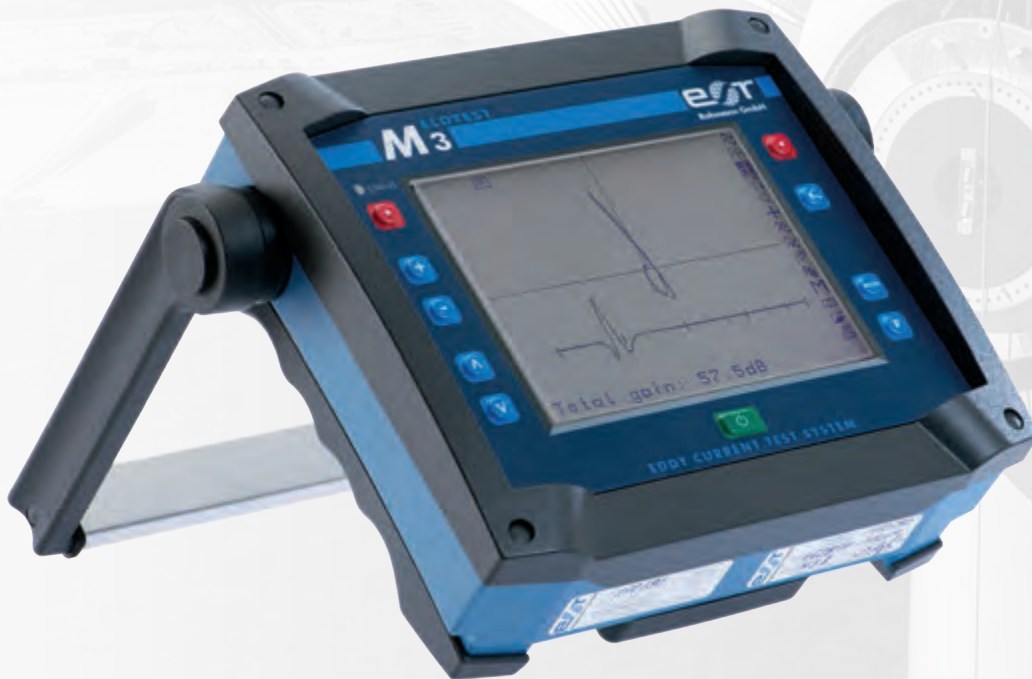

ELOTEST M3 in a desk housing

small and light – great performance

The ELOTEST M3 has the same performance specification as the smaller full eddy current test instrument – the ELOTEST M2 V3 – only with a significantly larger display.

Advantages:

- ▶ High resolution screen, daylight-compatible
- ▶ Ideal for difficult tasks
- ▶ Complete frequency range from 10 Hz to 12 MHz
- ▶ All filter functions – low pass, high pass, bandpass (optimised special filter for rotor mode)
- ▶ Large amplification range
- ▶ 2-frequency operation, independently variable (1 probe)
- ▶ Icon-guided operation via 10 keys (double compensation)
- ▶ All standard probes can be connected
- ▶ Set up as standard for rotor mode

Our customers use the ELOTEST M3 for manually testing surfaces, holes and concealed structures, as well as for measuring conductivity and layer thicknesses.

Hand-held eddy current tester

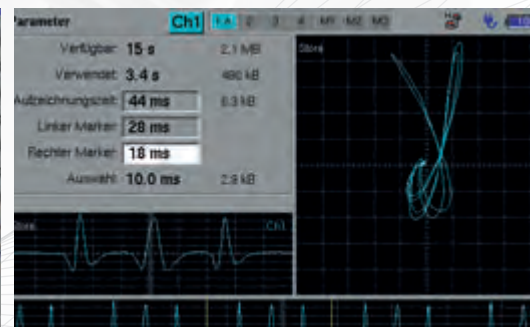

ELOTEST B300

for laboratories, training and portable applications

The ELOTEST B300, based on the outstanding eddy current characteristics of the ELOTEST B1, keeps options open for the future:

- ▶ Expandable to a maximum of 4 eddy current test channels and up to 2 probes
- ▶ Ideal networking capability, VGA output e.g. for projectors
- ▶ Suitable as universal laboratory and field operating device
- ▶ USB port for storing and logging data
- ▶ Fitted with a scanner interface
- ▶ Battery operation up to approx. 6 hours
- ▶ C-Scan recording for testing of bore holes
- ▶ Stripchart recording
- ▶ Conductivity and coating thickness measurement

With our „Scanalyzer“ data capture, analysis and documentation software, you can use the extraordinary eddy current characteristics of the ELOTEST B300 with a wide variety of scanner systems to carry out high resolution tests and document these comprehensively.

Eddy current test instruments for the production line



ELOTEST IS3

single channel eddy current test instrument for automated testing tasks

The ELOTEST IS3 in-line eddy current test instrument – for integration into automated testing machines. The single channel test instrument is designed with protection class IP54. It can be integrated directly into the production process, for example for automatic screw testing machines. It can be easily integrated into existing systems.

With a frequency range from 10 Hz to 12 MHz, a universal signal filter and I/O interface, this test instrument is an efficient alternative for fast crack detection and sorting tasks.

Eddy current test instruments for the production line



ELOTEST IS500 Box

for crack detection and/or multi-frequency material testing directly in the production line

The ELOTEST IS500 is characterised by its dynamic of 96 dB (digital) over a frequency range of 10 Hz to 12 MHz and, moreover, its fully digital signal processing chain on the low frequency side (after demodulation) with 10 kHz bandwidth and with fast multiplexing capability of 32 kHz multiplex rate (probe to probe). Up to 8 probes per channel can be connected via an external multiplexer. A maximum of 2 test channels can be used for crack detection and/or structural testing.

The sharpness and brilliance of the display are compelling. This is achieved digitally: the display of an analogue tube display with adjustable persistence is simulated, providing an accurate display of the test results.

Eddy current test instruments for the production line



ELOTES IS500 19"

digital eddy current testing for the metal working industry

This equipment series has the same specification as the ELOTES IS500 box, but is supplied as a 19" version for integration in existing cabinets.

Main features:

- ▶ For crack detection and/or structural testing
- ▶ Distance compensation
- ▶ Multiplex mode
- ▶ Sorting channel module with „Bubble Gate“
- ▶ Structural testing and sorting check with „Multilot“
- ▶ Retroactive teaching with „RetroTeach“
- ▶ FastSort Option
- ▶ Mix Function



ELOTES PL500

the eddy current test system for use in the production process

The ELOTES PL500 is the fastest device in its class on the market. It is the first eddy current testing device from the new series, „Specially designed for in-line testing“ with:

- ▶ 19" industrial housing with 4 Hu
- ▶ Extendible by up to 16 channels as standard
- ▶ In addition to test channel modules, distance compensation and multiplex modules are available, as well as various I/O modules
- ▶ Dynamic of 96 dB (digital) over a frequency range of 10 Hz to 12 MHz
- ▶ The latest digital signal-processing technology on the low frequency side with 100 kHz bandwidth
- ▶ Fast multiplexing capability of 32 kHz (probe to probe) up to a maximum of 32 probes/channel
- ▶ Very high test speed, as well as very high sensitivity and low noise
- ▶ Precise resolution
- ▶ Simple integration in client systems through support for current bus-based I/O concepts (e.g. Profibus)
- ▶ Customer-specific system interfaces can be easily implemented

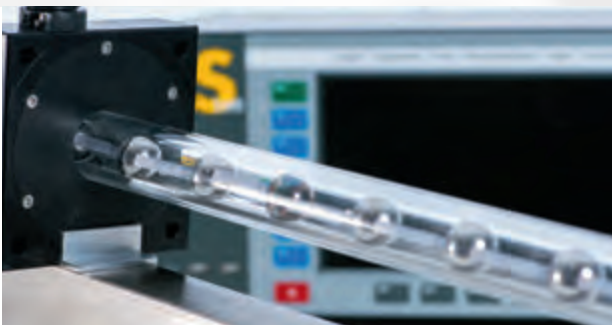

Eddy current test instruments for the production line



ELOTEST PL600

pioneering eddy current testing

The ELOTEST PL600 is a digital eddy current test instrument which leaves no wish unfulfilled. A flexible software system allows components to be inserted which are customised for each application, so that the operation can be carried out quickly and reliably. A licensing system allows you to match the performance of the device to the task and makes it a safe investment at an affordable entry price. A solid concept for replacement parts and service reduces operating and maintenance costs and enables maximum availability.

- ▶ Maximum stability with unsurpassed signal purity for best results with classical eddy current and harmonic analysis
- ▶ Suitable for all types of eddy current testing: Crack, heat treatment, material mix-up and grinding burn testing
- ▶ Maximum test reliability through comprehensive system and sensor monitoring
- ▶ Application-specific user interfaces for simplest operation
- ▶ Full integration through extensive I/O functions with fieldbus connection
- ▶ Modular design allows flexible expansion with easy maintenance
- ▶ Frequency range from 10 Hz to 12 MHz

Eddy current test instruments for the production line

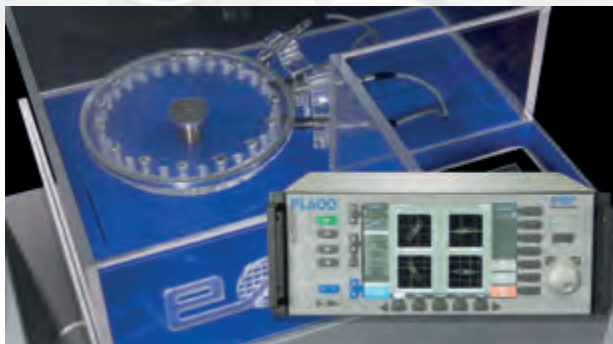
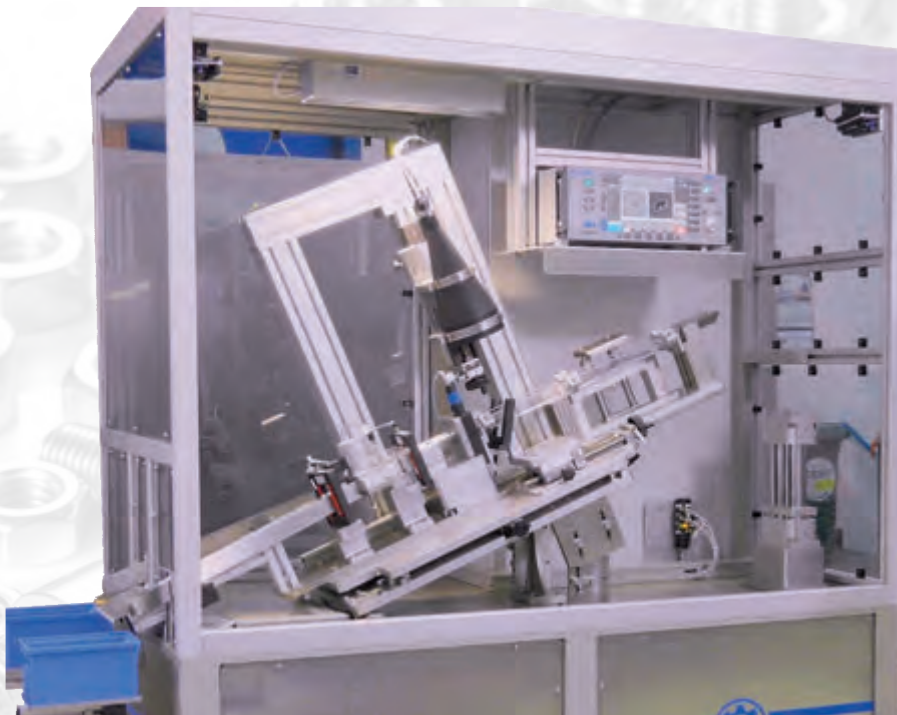

ELOTEST PL600 with FastSort

fast sorting with 1, 4 or 8 frequencies – optionally with harmonic analysis

The „PL600 with FastSort“ is used to determine material properties, hardness differences and/or geometric variations. It requires no external or time-shifted trigger signals or mechanical stops to hold the part in a specific position during evaluation.

The „FastSort“ activates itself by part detection via a simple signal threshold. It searches for the reversal point of the test signal for optimal centering of the part under or in the sensor.

This opens up a variety of applications as no external synchronization is required and the parts can be evaluated as fast as provided by the handling system (up to 200 parts per second).

1-frequency, 4-frequency, 8-frequency „FastSort“.

Advantages:

- ▶ Balancing in air
- ▶ Automatic balancing by using the PLC interface
- ▶ Sorting with basic frequencies and/or 3rd, 5th, 7th harmonics
- ▶ Automatic part detection
- ▶ Very fast sorting with up to 200 parts per second (depending on the frequency adjustment and the number of frequencies)

ELOTEST PL600 with Multiplex

with the ELOTEST PL600 a wide variety of multiplex applications are possible

- ▶ Parameter and sensor multiplex for up to 64 virtual mux channels per channel
- ▶ Complete eddy current parameterization per mux channel
- ▶ Multiplex rate up to 250 kHz (switching rate mux channel to mux channel)
- ▶ Internal sensor multiplexer for two sensors
- ▶ Control of external sensor multiplexers (multiplex rate from sensor to sensor up to 125 kHz; depending on test frequency)

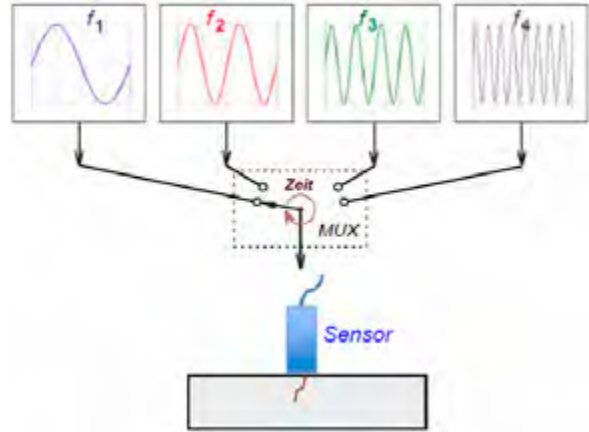

Parameter Multiplex:
Several parameter sets on one sensor

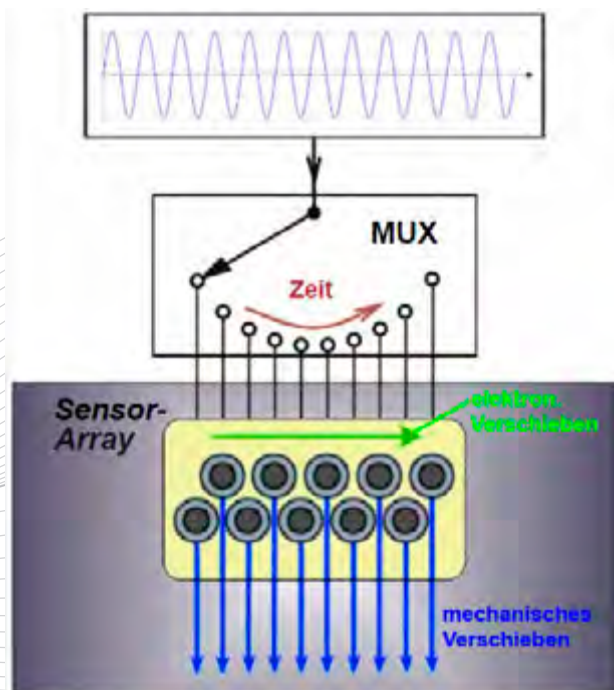

Sensor Multiplex:
Several sensors or sensor array with one parameter set

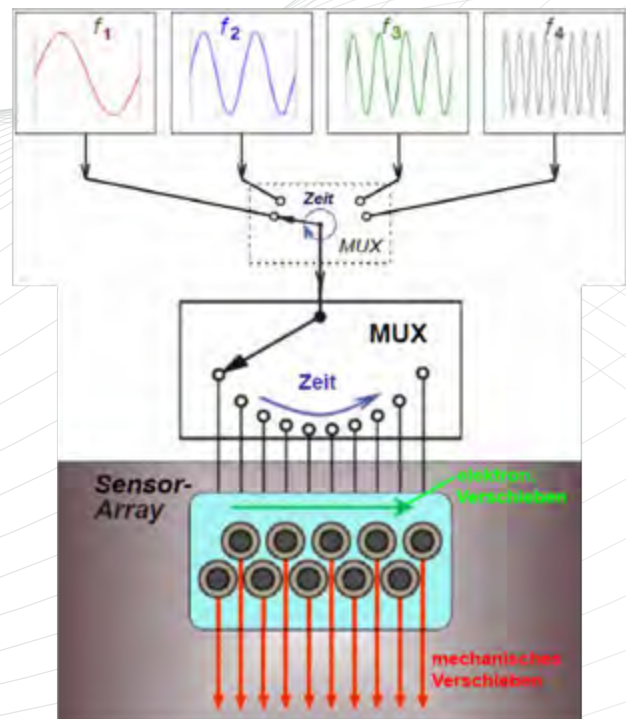

Combination of parameter multiplex with sensor multiplex

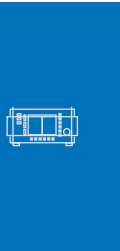

Eddy current test instruments for the production line

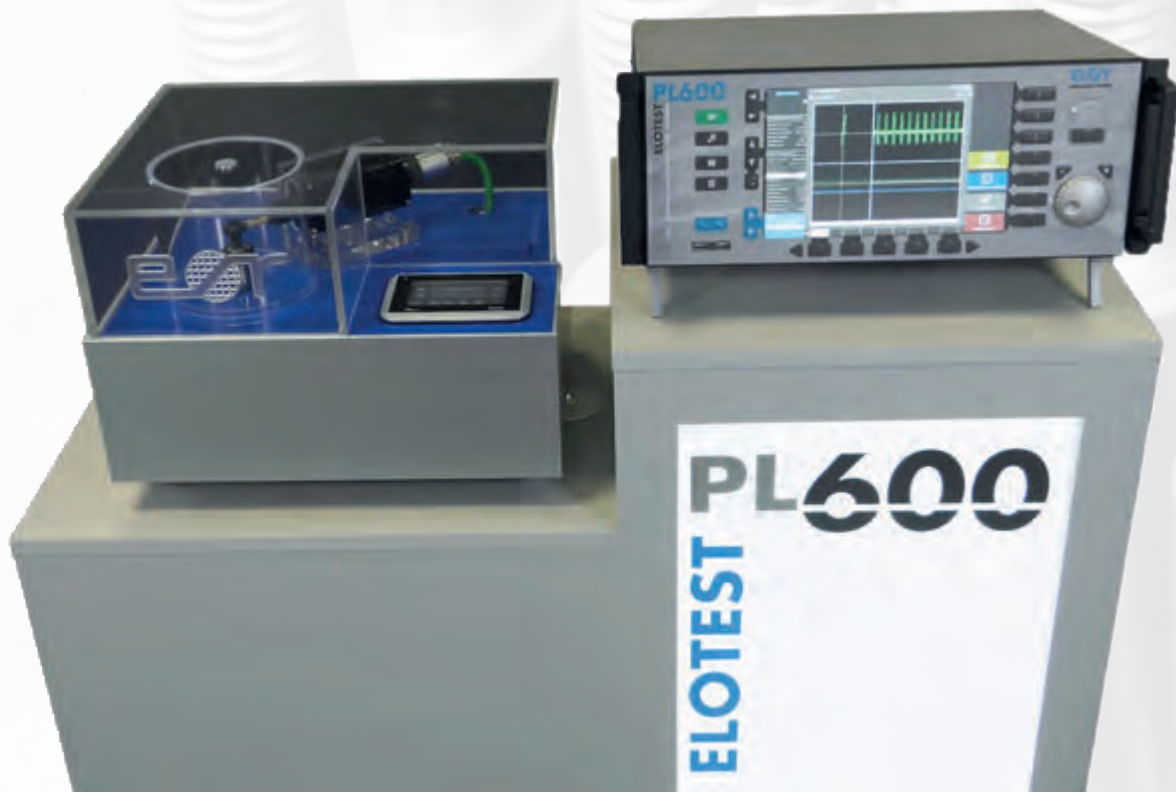

ELOTEST PL600 with EMDC

Electro Mechanical Distance Compensation (EMDC)

The distance of the sensor relative to the part being tested is the most decisive influencing factor for the sensitivity of eddy current testing. If the sensor distance cannot be kept constant, 2 measures can be taken: By default, we deploy special distance compensation probes in combination with use of the electronic distance compensation from the Instrument PL600 which works for distance variations up to 1 mm (+/- 0,5mm).

For bigger distance variations or parts which are not round (for example eccentric bolts) we can provide the "Electro Mechanical Distance Compensation – EMDC" which can control the distance up to a range of 15 mm by repositioning the sensor.

Difficult inspection tasks can be carried out using Rohmann's EMDC-Technology, for example, on:

- ▶ Non-circular test parts
- ▶ Parts presenting concentricity problems
- ▶ Eccentric fixation of the parts being tested or any unwanted distance variations

Eddy current test instruments for the production line

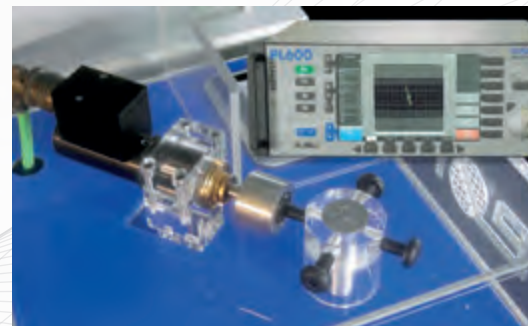

ELOTES PL600 with HDR18 and tulip probe

for crack inspection on bolt head

- ▶ Industrial Heavy Duty Rotor (HDR) for the inspection of bore holes, bolt head, nuts, etc.
- ▶ High speed crack inspection in automated systems
- ▶ 1 or 2 test channels – 2 probe positions
- ▶ Electronical distance compensation for +/- 0,3 mm for each test channel
- ▶ High rotating speed with 4.000 rpm

Eddy current test systems



ELOTES PL600 with tolerance band threshold

testing hardness curve on shafts

The tolerance band threshold uses path-based eddy current signals. Two types of tolerance band thresholds are available:

- Tolerance band Y-d (way-based amplitude of the vertical signal component) and
- Tolerance band X-d (way-based amplitude of the horizontal signal component).

An external signal is required which carries the position information, e.g. an analog input, a digital input or encoder signals (incremental or absolute).

For the eddy current data, a certain “band” threshold is applied, representing a pair of upper and lower distances. This creates a kind of “multiband” threshold for the entire travel range.

Up to 125 test positions can be used over the entire travel range.

- ▶ Testing hardness curve on shafts
- ▶ Inspection in different positions (up to 125)

Eddy current test systems



ELATEST PL600/R with touchpanel

ELATEST PL600/R „Remote“ and ELATEST PL600/RC „Remote Compact“

For special needs a “remote” version of the ELATEST PL600 is available equipped with the same hardware components except the user interface.

The ELATEST PL600/R provides the entire set of functionalities without restrictions and is remotely controlled by a touch screen or a PC-client.

ELATEST PL600/R - maximum 16 channels

ELATEST PL600/RC - maximum 4 channels

The minimum hardware configuration morely consists of an eddy current channel module CHM-600 and an the interface module I/O-602.

Eddy current test systems

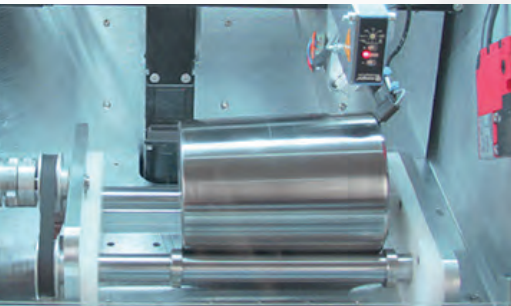

QutEC.mini with ELOTEST IS3

grinding burn and crack testing of cylindrical parts

Universal testing system for semi-automatic testing with highest precision and repeatability.

Contour tracking via optional 4th axis (sensor rotation) and open programming (G-code or CAD import). Ideally suited for high-resolution crack detection and grinding burn testing.

Options: various component fixtures (three-jaw chuck, chuck, rollers etc.), Q.3D (end faces, radii etc.), C-Scan, barcode or DMC reader, RFID authorization for NIO removal.

Integration of ELOTEST B300, or other line test instruments of the ELOTEST family and KAS-34/KD-38 or similar sensors for inspection of rings, rollers, ball studs, valves, bushings, screws.

- ▶ Use for grinding burn testing and crack detection
- ▶ 4-axis ET inspection system
- ▶ Easy to use parts selector via touch screen
- ▶ Part rotation by 2 driven rollers and / or chuck
- ▶ Interchangeable probes for crack detection or grinding burn test of the lateral and face surface including transmission radius Rollers and chucks
- ▶ Exchangeable probes for crack detection or grinding burn testing of the shell surface and the end surface

Eddy current test systems

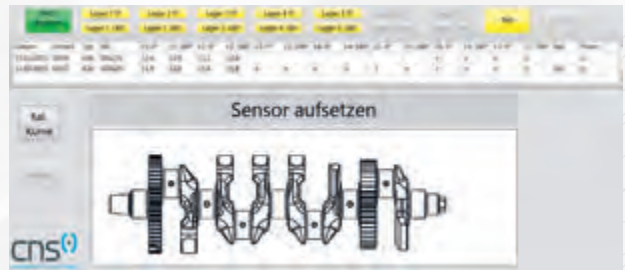
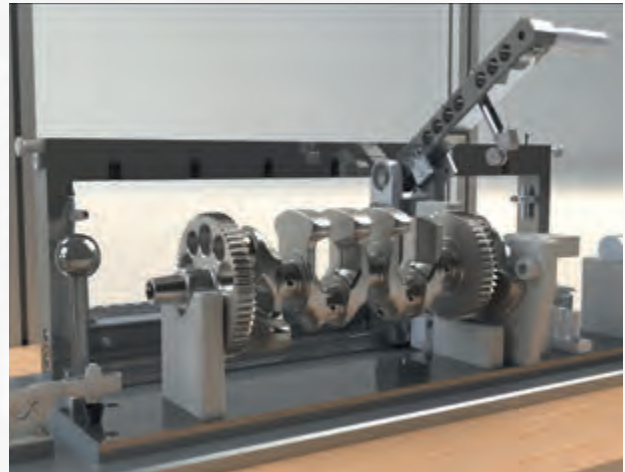

QutEC.sbc chain wheel – In-Line-System for crack detection

QutEC.sbc and QutEC.deltaS with PL600

crack testing of parts made of sintered material and ferromagnetic μ -layers on ferromagnetic base material

Testing of all rotationally symmetric components optional optical measurement of the component geometry.

- ▶ Cycle time 2s/part
- ▶ Conversion to up to 8 types
- ▶ ELOTEST PL600 with KD-38 probe

Delta.S – the only non-destructive method available on the market for measuring the thickness of nitrocarburized layers (ferromagnetic base material and ferromagnetic layer!)

- ▶ Measuring range 5 ... 30 μ m, resolution better than 1 μ m
- ▶ ELOTEST B300 or IS500 with probe KAS-3
- ▶ Applications: crankshafts, synchronizer rings, bucket tappets

Eddy current test systems

FlexiTest with ELOTTEST IS3



Mechanics produced by n-dect GmbH, test instruments and Software by Rohmann GmbH



FlexiTest and ELOTTEST PL600 with Scanalyzer

(see page 41)

Flexible 2-axis Eddy Current desktop crack test system

turnkey systems · non destructive testing

This compact and modular system closes the gap between a manual device and a fully automatic testing system. Once the test piece has been inserted, the automated test sequence starts. The spindle sets the test piece in rotation and a probe moves along the test piece by means of two interpolating servo axes. After completion of the test, the sorting result is displayed optically and acoustically.

- ▶ Test parts up to \varnothing max. 50 mm, length max. 120 mm
- ▶ Within a few minutes new process and new Test positions can be created
- ▶ Part clamp versions (quick change system)
 - ▶ Manual chuck
 - ▶ Mandrel for mounting the test parts
- ▶ Tailstock (manual or motorized) for clamping between centres and centering
- ▶ Support prism
- ▶ Examples for additional options
 - ▶ Pedal switch
 - ▶ Automation interface
 - ▶ Integration of Rohmann Test Instruments ELOTTEST IS3, IS500, PL500

Eddy current test systems



Eddy current testing system with ELOTEST PL600

for crack detection on axle flange/wheel flange

System for crack detection on wheel bearing flanges in the area of the heat-affected zone and the brake discs radius. A magneto-inductive microstructure test can be integrated as an option. The system is mounted on a welded steel frame and includes a Flexlink conveyor belt for part transportation. For crack detection, the wheel flange is lifted out, clamped and accelerated to test speed. The eddy current probe is mounted on a 3-axis system with interpolating path control and is guided along the type-specific programmed probe path perpendicular to the test surface. After material sorting, the good parts are placed on the FlexLink belt and the bad parts on a roller conveyor with a capacity of max. 5 parts. Cycle time: approx. 8.0 seconds per part (optional up to 6.0 seconds possible)

Reference defect dimensions (crack testing)

- ▶ Longitudinal crack: 3.0mm x 0.075mm x 0.100mm (LxWxD)
- ▶ Peripheral crack: 3.0mm x 0.075mm x 0.150mm (LxWxD)

Size spectrum of the test parts

- ▶ Outer diameter from 120 to 165mm
- ▶ Height from 60 to 90mm and weight up to 5kg

Eddy current test systems

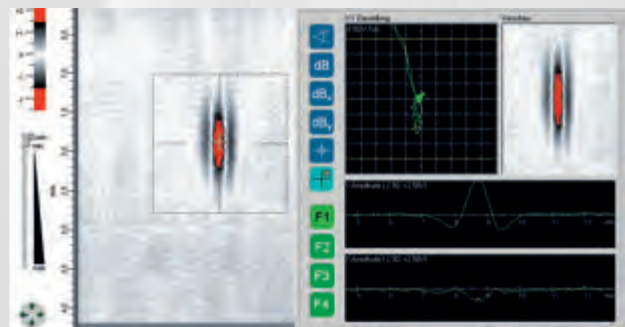
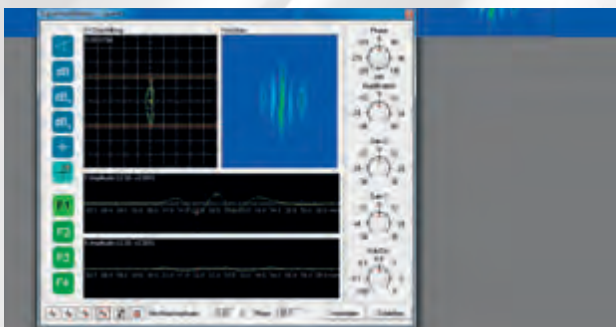

EloScan

the flexible robot testing system

The EloScan system, with its precise probe guidance, is designed for eddy current testing of rotationally symmetric aero engine components and for complex geometries. Our test systems meet and surpass many technical test criteria for the automated testing of aero engine components from a wide range of aero engine components manufacturers. The multiple-axis industrial robot works with a Rohmann eddy current device and a special version of the ScanAnalyzer software in accordance with various test instructions. The following main components are integrated in the EloScan system and offer you a user-friendly complete system:

- ▶ Precise probe guidance and positioning of the components under test
- ▶ Positioning turntable with three-jaw chuck for flexible clamping of components and adapters
- ▶ „Teach-in” terminal with colour screen
- ▶ ScanAnalyzer software: Eddy current signal recording, depiction and analysis
- ▶ Optional: CAD-CAM programming for complex tests
- ▶ Tool changer for automated processing of a variety of test tasks

Eddy current test systems



Usable with track gauges from 1400 up to 1700 mm.



Draisine WPG D340

eddy current technology applied to railway tracks

The Rohmann trolley was specially developed to detect and evaluate cracks at the rail edge, so-called head checks. Thanks to its ultra-light carbon fibre construction, the system can be operated by one man and lifted off the track in a matter of seconds. Four special sensors sliding on the surface check a range of 24 mm and can be adjusted to 20 different positions. The patented magnetic guide keeps the whole system stable on the track without any mechanical clamps, even in elevated curves. Only this guide system makes it possible to inspect rails in turnout systems without interruption. The specially developed EloRail software is easy to operate and can be adjusted to different inspection tasks. The test can be monitored directly on the optional outdoor notebook and special events such as welds or insulation joints can be marked at the touch of a button.

The Draisine WPG 340 eddy current testing system has been approved as a test device since March 2011 of DB Netz AG.



Eddy current test systems



EloWheel RPT17



EloWheel 800 RPT17 and EloWheel 1000 RPT16

eddy current testing system for aircraft rims

With the EloWheel RPT17 and RPT16, aircraft rims up to a diameter of 800 mm or 1000 mm and a maximum weight of 250 kg can be tested. The associated EloWheel software visualizes the eddy current signals in such a way that the test results can be reliably evaluated. The system condition is permanently monitored and visually displayed to the operator.

A comparison of historical and current data allows to track the life cycle of individual rims. The design of the test mechanics permits tests with the highest throughput and ensures the required test resolution. Particular attention was paid to user-friendliness and ergonomics.

Eddy current test systems



Mechanics produced by Rohmann LP, test instruments and software by Rohmann GmbH

Software EloWheel RPT17 and RPT16



EloWheel RPT16

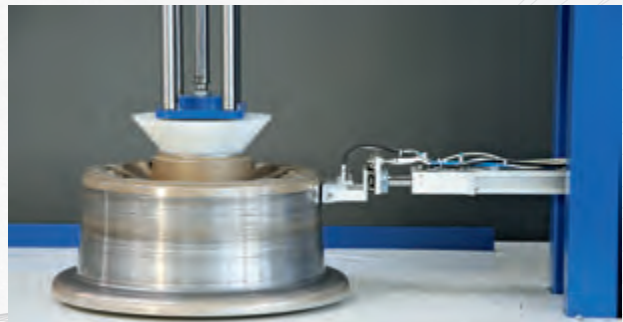

- ▶ Fast testing speed of up to 120 rpm for smaller wheels
- ▶ precise linear guidance with a high-quality axis motor control enables vibration-free probe guidance
- ▶ Double testing of surface and interior possible with a double test probe, HF and NF testing in one operation
- ▶ Current hardware components and software version (Windows 10)
- ▶ C-scan image
- ▶ Offline evaluation (e.g. with Office Scanalyzer license)
- ▶ Database-driven file system for the completed checks including search function
- ▶ Test report as PDF or direct printout incl. C-Scan
- ▶ Reliable heavy steel frame construction
- ▶ Complete clamping of the wheel half during inspection

- ▶ Remote maintenance access and connection to company network possible

New features of the EloWheel RPT17

- ▶ Compensation unit on clamping cylinder for mechanical decoupling
- ▶ Flexibly positionable control cabinet
- ▶ Low space requirement of the system with integrated and smooth-running operator protection
- ▶ Connection to external databases possible
- ▶ Turntable positioning on defects by means of servo drives and axial position laser
- ▶ Can be integrated into partially or fully automated conveyor lines

Eddy current test systems



ELOTEST HST

Heavy Plate Hard Spot Tester

The ELOTEST HST test trolley was developed for the detection of partial hardening on heavy plates. It is designed for manual testing of large-area semi-finished products with the EDDY+ method. Its modular design can be adapted. The test signals are displayed directly on the Toughbook as C-Scan. In addition, the device status is visualized to the operator via clearly visible LED signal lamps. This makes the ELOTEST HST inspection system predestined for use in harsh steel mill environments. Two powerful, integrated lithium-ion rechargeable batteries make the inspection system independent of mains power.

- ▶ 2 test channels each with a 4-fold multiplexer
- ▶ Sensor heads with 8 individual sensors per test channel
- ▶ 100% test area coverage
- ▶ max. test width 640 mm
- ▶ max. test speed up to approx. 1m/s (normal step speed)
- ▶ Testing time up to 10 hours per battery (can be switched from the first to the second battery during operation)
- ▶ Weight approx. 98 kg (including 2 batteries)

Integrated test systems are available for automated applications in the production line.

Eddy current test systems



BoltScan

universal eddy current testing device

Universally applicable, semi-automatic testing device for screws, bolts, sleeves, rotationally symmetrical parts with and without shoulder. Testing with adjustable rotation and automatic probe feed.

- ▶ A large number of test probes are available for different test tasks. The multi-function probe holder allows almost any test position to be set.
- ▶ Infinitely variable part speed adjustment
- ▶ Feeding direction switchable
- ▶ Automatic stop by limit switches in the end positions
- ▶ Probe feed infinitely adjustable
- ▶ Infinitely adjustable distance of the support rollers via central adjustment
- ▶ Parts slippage is prevented by rubberized rollers and distance changes of the support rollers.
- ▶ Floating probes Holder
- ▶ Adjustable part stop
- ▶ Test probe KA-36 H-1705.04.1

Eddy current test probes



Probes

are the “eyes” of our test systems

The most important condition for a successful eddy current test is the use of ideal probes. This is why we take particular care with the development and production of probes and probe systems, taking into account national and international standards, as well as manufacturer and user regulations.

With our many years of development work and a range of hundreds of probes, we have the expertise to design individual probes for complex test tasks.

Eddy current test probes

Standard and Special Probes



Rotating probe with flexible shaft



Rotating probe



Rotating probe for holes larger than $\varnothing 0.8$ mm



Rotating probe with flexible shaft and ball head



KDS 2-2, differential probe in metal housing, high-resolution and shielded



KAS 31-H-1575, absolute probe, geometrically adapted



PLA 33-11, absolute probe, e.g. for material verification testing



Manipulator-compatible probe, adapted for inspecting complex geometry



Probe guide for manually inspecting crankshafts



PKA-5 H-1668, transmission probe, for material verification testing



LD-15 H-1837.06.1, dual differential probe for inspections on the rail foot



KA-33 H-1644, absolute probe for cam inspection



ARK 31-2, standard probe for crack detection on multi-layer aluminium structures



KD-118 H-1869, differential probe with guide for crack detection



LD-15 H-1837.04.3, differential probe for inspections on the rail foot

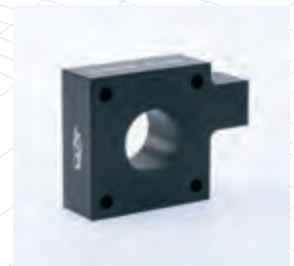

ULAS-13 H-1469 encircling sorting coil, small size 45 x 45 mm



PKA-9 H-1092, standard probe with high penetration depth for aluminium



Miniature sensor, absolute, ready for installation in a guiding tool

More information can be found in our probe catalogue.



Eddy current test probes

Applications



Root and flank defects on tubes with many fins



Longitudinal and transverse defects on fine wires



Grinding burn and cracks on camshafts



Pinholes, cracks and welding defects on multi-fuel valves



Micro-cracks on rollers



Dynamic hole inspection from \varnothing 0.8 mm



Inspection of grinding burns and cracks on rotating components



Layer thickness and pinhole inspection on aluminium tubes



Crack detection on tooth root, contactless



Manipulator-compatible miniature probes



Crack detection on complex structures



Crack detection on safety relevant structures

Eddy current test probes



Hand-held rotors and rotating probes

absolute probes, differential and multi-differential probes

Dynamic testing for minute defects with high local resolution and great sensitivity, carried out almost independently of the feed speed. At the same time, the highly developed filtering technology in our test systems is employed to the full, most interfering effects can be suppressed.

We have the appropriate system for all investigations of plane surfaces, small and large holes, pipe interiors and exteriors – ranging from 0.8 mm to 200 mm.

Eddy current test probes

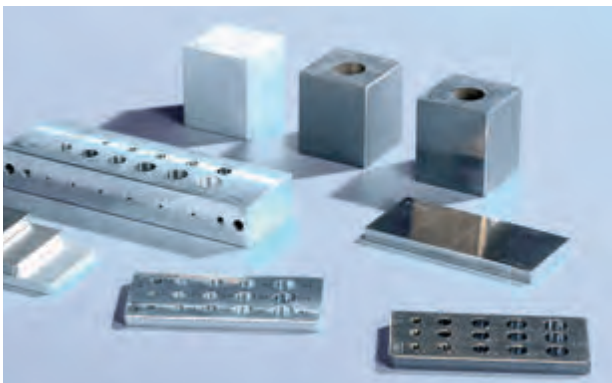

Reference standards

from the simple version with groove to complex geometries

Calibration, adjustment, functional checking – this kind of work requires reference standards. As the eddy current method is an indirect testing process, reference standards with artificially produced defects are needed to reproduce the appropriate comparison signals. We normally use prepared reference standards to test materials for damage. Defects of every kind are visible. For example, we simulate cracks with grooves, corrosion damage with milled out sections, etc. Our systems also detect hidden damage via holes from the rear.

- ▶ available with calibration certificate

Eddy current test probes



Encircling coils

for testing wires, bars and tubes

Our comprehensive encircling coils with differential and absolute systems are used to test wires, bars and tubes with diameters from 2 - 180 mm.

For testing ferromagnetic materials, we supply compact magnetizing and demagnetizing yokes in various gradations that are convection-cooled and do not require external cooling.

Sorting and segment coils

up to 270 mm diameter are also part of our standard range

► Customized coils can be requested at any time.



Eddy current test rotors

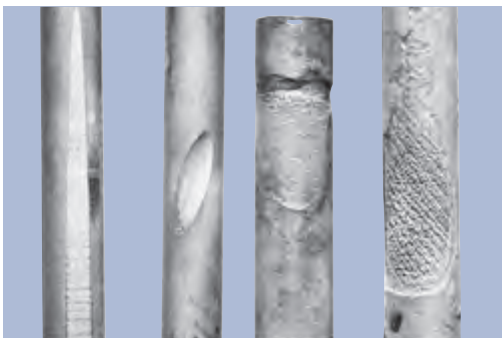

IHR-rotors

Available stanrd sizes:

RotorTyp	internal \varnothing min	internal \varnothing max
IHR16	17,5 mm	25,0 mm
IHR18	23,0 mm	30,0 mm
IHR25	30,0 mm	50,0 mm
IHR32/2-2	from: 40,0 mm	
IHR40/2-2	from: 50,0 mm	
IHR60/2-2	from: 70,0 mm	

Tube interior inspection

for simple inspection of built-in tubes

With our internal coils, you can check tubes with diameters from 5 to 50 mm – using bridge coils in a differential circuit. Where as point-shaped and circumferential defects are visible with this method, dynamic tube testing with an interior rotor also enables detection of longitudinal damage, as well as checking for eccentric wear on the tube.

Eddy current test rotors

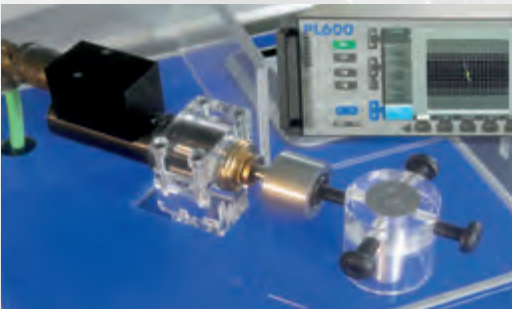

Rotoren HDR17/HDR18

in various designs

Rohmann customers use robust heavy-duty rotors with disc probes up to 300 mm in diameter for fast and economical testing of sheet metal, billets, rails and profiles for surface damage. With high-resolution internal rotors, the smallest surface damage can be found in pipes and deep bores from 17,5 to 300 mm in diameter.



Eddy current test rotors



Rotor EC15 compact

the high performance rotor in a high-strength anodised aluminium housing

The EC 15 compact rotor is a compact, high performance rotor for contactless in-line testing of circular materials, such as wires, bars and tubes in a range of dimensions from 1.5 to 15 mm.

The compact construction of the rotor means it can easily be built into test lanes or transport lines. It is only 139 mm long and 70 mm wide and has an average run-through height of 35 mm. The detection of longitudinal and transverse defects with longitudinal components is possible with corresponding surface and microstructure quality from 20 µ defect depth.

The test track width is defined via the task using appropriate probe systems. A 24V motor provides the drive. With a speed of 3,000 rpm, the contamination-protected (labyrinth seal) rotor, mounted in precision bearings, operates efficiently with contactless, zero-maintenance test signal transmitters.

Eddy current test rotors



Diameter ranges of the available sizes:

- ▶ EC15 1,5 mm – 15 mm
- ▶ EC30 5 mm – 30 mm
- ▶ EC40 5 mm – 40 mm
- ▶ EC65 5 mm – 65 mm
- ▶ EC100 10 mm – 100 mm
- ▶ EC130 10 mm – 130 mm

The data refer to the free passage.

Rotors EC30 - EC130

for automatic testing of tubes, rods and wires

Rotors and continuous coils are the most common sensor systems for testing semi-finished products and finished parts. The speed of our high-performance rotors are in the four- to five-digit range, depending on the model. Material diameters from 5 mm to 130 mm can be tested.

Rohmann rotors are characterized by a long life time, robust construction and low maintenance costs. Depending on the testing task, they can be

- ▶ in 4-channel version,
- ▶ with or without distance compensation,
- ▶ can be configured with fixed or adjustable sensors.



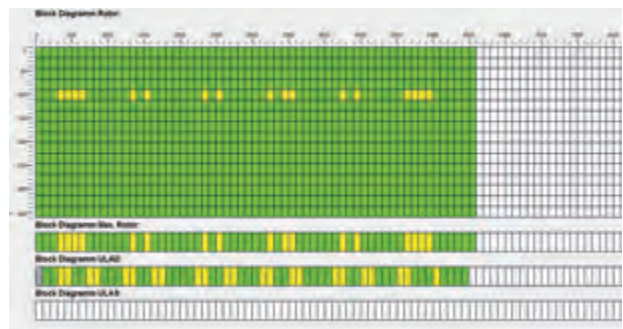
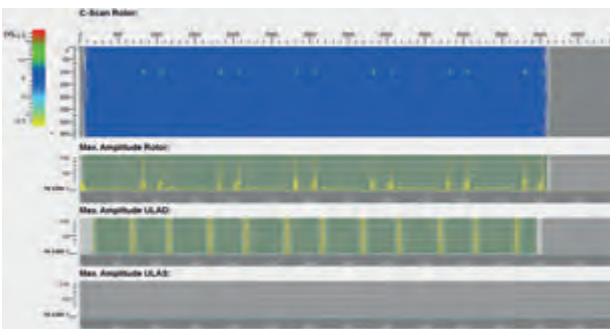

EloLine

Software for documentation of test results on long products

EloLine is a standard software for visualising and documenting test results for eddy current testing of long products. This software is used for testing with encircling coil systems up to complex multi-channel rotor or multiplex applications:

- ▶ Processing and analysis of a maximum of 8 test channels possible
- ▶ Flaw-suspicious areas found will be marked accurately in the C-scan
- ▶ Compatible with the ELOTEST PL500/PL600 equipment platform and the latest operating systems
- ▶ Various forms of visualisation representation

Software



Mechanics produced by n-dect GmbH, test instruments and Software by Rohmann GmbH

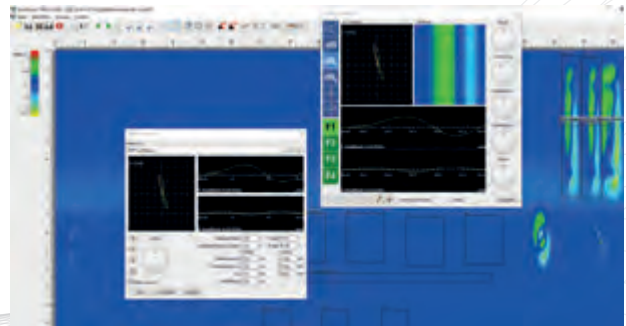
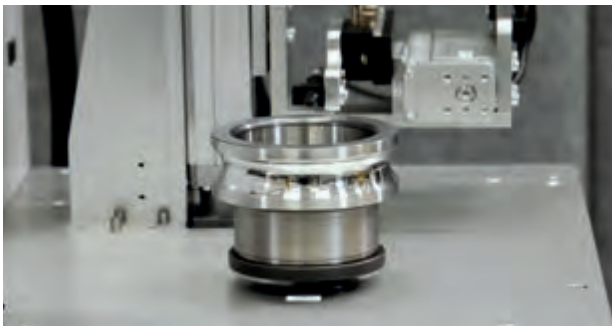

Scanalyzer

the software tool for documentation and analysis

Scanalyzer is a universally applicable testing, documentation and analysis software for fast and safe creation of C-scans. Leading powertrain manufacturers, chemical companies, automotive suppliers and power station operators work with this software. The system combines powerful PC software with modern eddy current testing systems. This way can be offers precise signal and condition analyses.

With its serial scan function this software can be used for the maintenance and production monitoring of safety-relevant components.

It can also be combined with conventional image processing for fully-automated testing.



Customer Test Systems

Efficient semi-finished product testing



Steel bar inspection with EC100 rotor

Steel bar testing

Bar testing in the production line. Steel bar testing for diameters 10 mm – 95 mm with EC100 rotor (4 channels).

Equipment:

- ▶ ELOTTEST PL500, 4-channel with 2 x DCOMP



Eddy current and ultrasonic tube testing system

Tube testing

Defect inspection on rotating tube using a combination of eddy current and ultrasonic. Eddy current testing for surface defects ultrasonic testing for defects inside the tube wall.

Equipment:

- ▶ ELOTTEST PL500, 1-channel, with multiplex and 6x array probes



Testing the weld seam

Weld seam testing

Defects in the longitudinal seam of welded tubes in the production line

Equipment:

- ▶ ELOTTEST IS500 Box test equipment, single channel, with adjustable weld seam probe

Customer Test Systems

Efficient semi-finished product testing



Tube inspection with probe array

Tube testing system – Large tube testing in the production line

TUB.EC 300 eddy current test system for automatic testing for surface defects (cracks, scales, pinholes) on hot-rolled tubes. Diameter range of the tubes to be tested: 50 - 300 mm.

Equipment:

- ▶ ELOTEST PL500, 6-channel with 8 × multiplex and 48 probe array



Inspecting wires / bars using encircling coils

Inspecting wires / bars using encircling coils

Contactless, fast and reproducible. These are the advantages of eddy current testing compared with all other non-destructive test methods. Whether single or twin channel with encircling coils in the magnetizing yoke, or with segment coils with permanent magnetisation – even in most confined spaces.

Equipment:

- ELOTEST PL500, 4-channel
- ▶ M170 magnetising coil



Multi-channel inspection with coils

Multi-channel tube testing with coils

Ten-channel, with independent coil array for individual evaluation on ten production lines.



Customer Test Systems

Efficient component testing

for mass inspection and single part inspection



Crack detection system with PL500

Eddy current crack detection on cylindrical components:

- ▶ 10 parts/second conveying speed, max. 100 mm/s

Typical defect specification:

Longitudinal cracks 0.05 mm deep × 0.05 mm wide × 3.0 mm long.

The parts are fed into the line, for example, by means of a vibrating bowl. The parts are gripped between the drive and brake discs and conveyed precisely and evenly by the rotating head.

Equipment:

- ▶ ELOTTEST PL500, 2-channel



System with ELOTTEST PL500

Metal plate test system

Testing of niobium sheets for minute tantalum inclusions (∅ 0.1 - 0.2 mm)

Equipment:

- ▶ ELOTTEST PL500, 2-channel

Efficient component testing

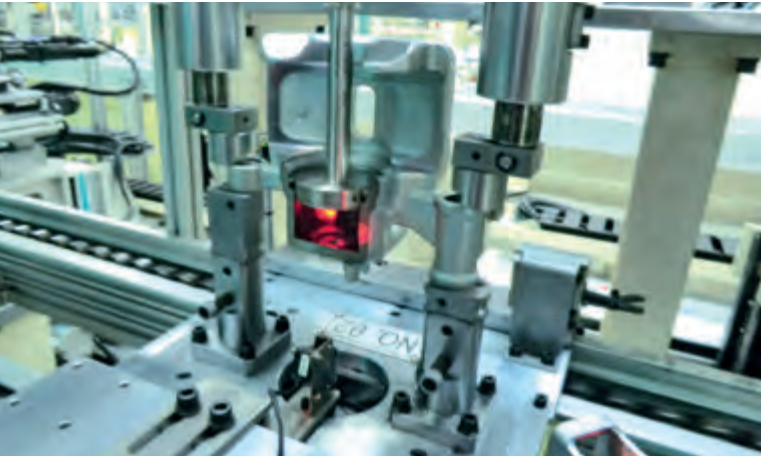

Brake calliper testing

Brake calliper testing

Locating metallic impurities, such as chips, in the sealing groove on a brake cylinder housing. The rotating probe penetrates the hole on the positioned part and inspects the region of the groove.

Equipment:

- ▶ ELOTEST IS500, single channel, with rotor and rotating probe



Fully-automatic crack detection on ball studs

System for fully automated crack detection on ball studs

Surface crack detection on ball studs as a final inspection of the finished machined component. In this case, as a substitution of magnetic particle testing, cracks from 3 mm in length and 0.1 mm in depth are detected.

Equipment:

- ▶ ELOTEST PL500, 3-channel with 1 distance compensation



Steering rods testing

Crack detection on steering rods

For cracks on the shaft and in the gear teeth. Hardness deviations in the vicinity of the gear teeth.

Equipment:

- ▶ ELOTEST PL500, 7-channel:
 - ▶ 1 channel with MDK probe for longitudinal cracks and transverse cracks in the cylindrical area
 - ▶ 2 channels with KDS probes for cracks starting to the right and to the left of the gear teeth
 - ▶ 3 channels with PLA probes for crack detection in the gear teeth
 - ▶ 1 channel with coil for hardness testing



Efficient component testing

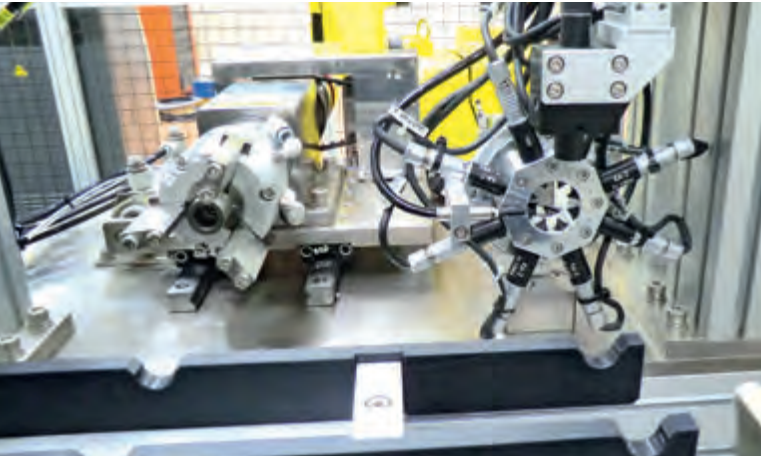

Testing driveshafts

Driveshaft testing

Structural deviations in the hardened regions driveshafts, hardness cracks on the shaft, in the grooves and in the gear teeth.

Equipment:

- ▶ ELOTEST PL500, 5-channel:
 - ▶ 1 channel for hardness testing
 - ▶ 3 channels for crack detection on the rotating part
 - ▶ 1 channel with multiplex and 7 probes for crack detection in the gear teeth



Piston testing with robot

Piston testing with robot

Robot-based inspection of hollow edge of pistons using triple probe.

Equipment:

- ▶ ELOTEST PL500, 3-channel, with formed triple probe



Steering rod recirculating ball races

Crack detection on the recirculating ball races of steering rods

Longitudinal and transverse defects from 2 mm length and 0.1 mm depth in all areas of the recirculating ball race.

Equipment:

- ▶ ELOTEST PL500, 6-channel:
 - ▶ 3 channels with formed special probe for testing in the base of the recirculating ball race
 - ▶ 3 channels with formed special probe for testing the flanks of the recirculating ball race

Customer Test Systems

Efficient component testing

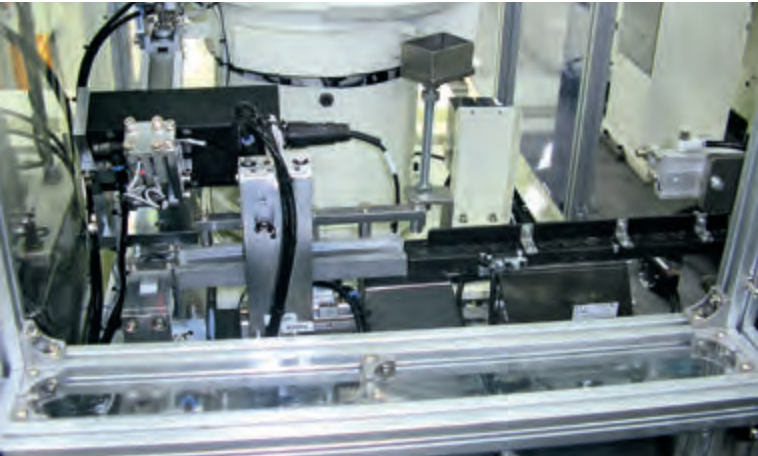

Testing discs

Testing disks

Hard/soft sorting, material verification and dimensional check.

The test is performed in slippage before assembly.

Equipment:

- ▶ ELOTEST IS500, single channel, with ULAS sorting coil

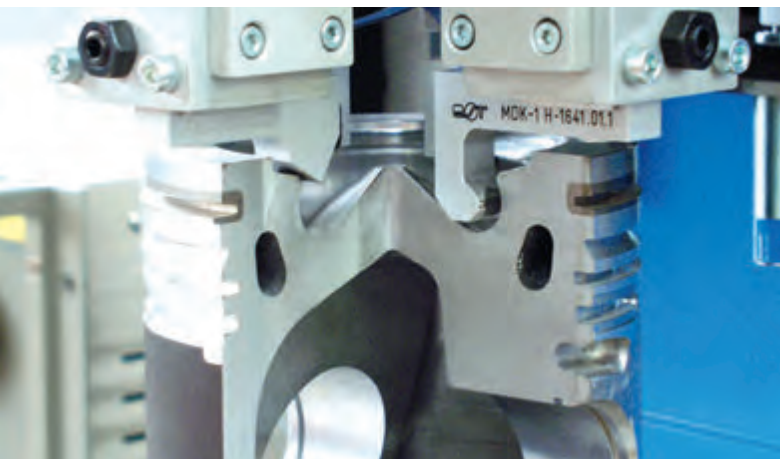

Automated inspection of pistons

System for automated inspection of pistons

Defect inspection on the bowl rim of automotive and truck pistons with up to 12 individual probes per test head. Depending on the design, defined minimum defects from 0.3 mm in diameter can be detected reliably by turning the piston or by using a multi-channel rotating head.

Equipment:

- ▶ ELOTEST PL500, 12-channel also available as a 2-channel version, multiplexed



Testing the cylinder lining

Engine block inspection

for cracks, pinholes, material structure and layer properties in the cylinder lining.

Equipment:

- ▶ ELOTEST PL500, 6-channel, with 6 high performance rotors and the use of formed special probes



Customer Test Systems

Efficient component testing

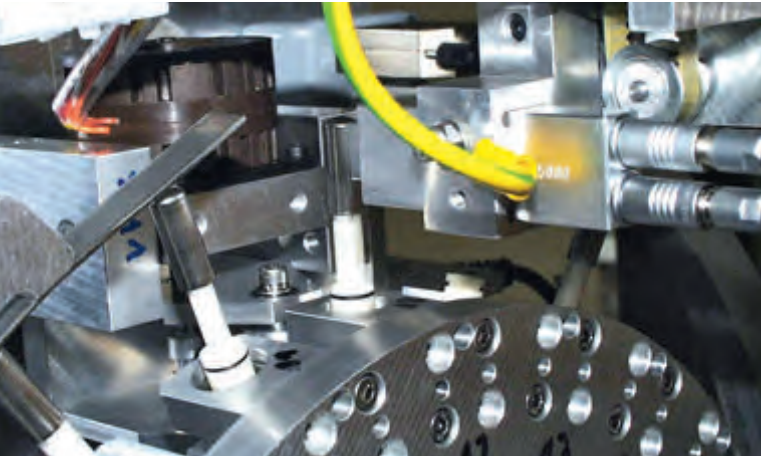

Crack inspection on deep-drawn bushings

Crack detection system for deep-drawn bushings

Maximum precision in a cycle lasting only seconds. The external surface of up to 4 deep-drawn bushings per second are inspected for typical drawing defects.

Equipment:

- ▶ ELOTEST PL500, 4-channel, multiplexed



Transmission component test system

Transmission component testing

Imaging eddy current test of transmission components for cracks and pinholes.

Fully-automated surface testing and analysis using highly precise probe guidance with a surface clearance of 0.4 mm along geometrically complex structures – and additional imaging analysis of the eddy current data recorded in the C scan. Compliance with the required cycle time for direct integration into the production line.

Equipment:

- ▶ ELOTEST PL500, 1-channel



Screw testing system

Screw testing

Sorting for hardness differences with sorting coils or probes for up to 5 test parts per second and up to 8 test frequencies. Crack detection on the screw head with 2-channel HDR rotor for up to 5 parts per second.

Equipment:

ELOTEST IS500 and PL500 with different channel numbers and configuration matched to the testing task.

- ▶ Coils and probes for detecting hardness differences
- ▶ Rotating 2-channel probes on the rotor for crack detection on the screw head
- ▶ Probes for crack detection in different positions on the rotating component

Notes

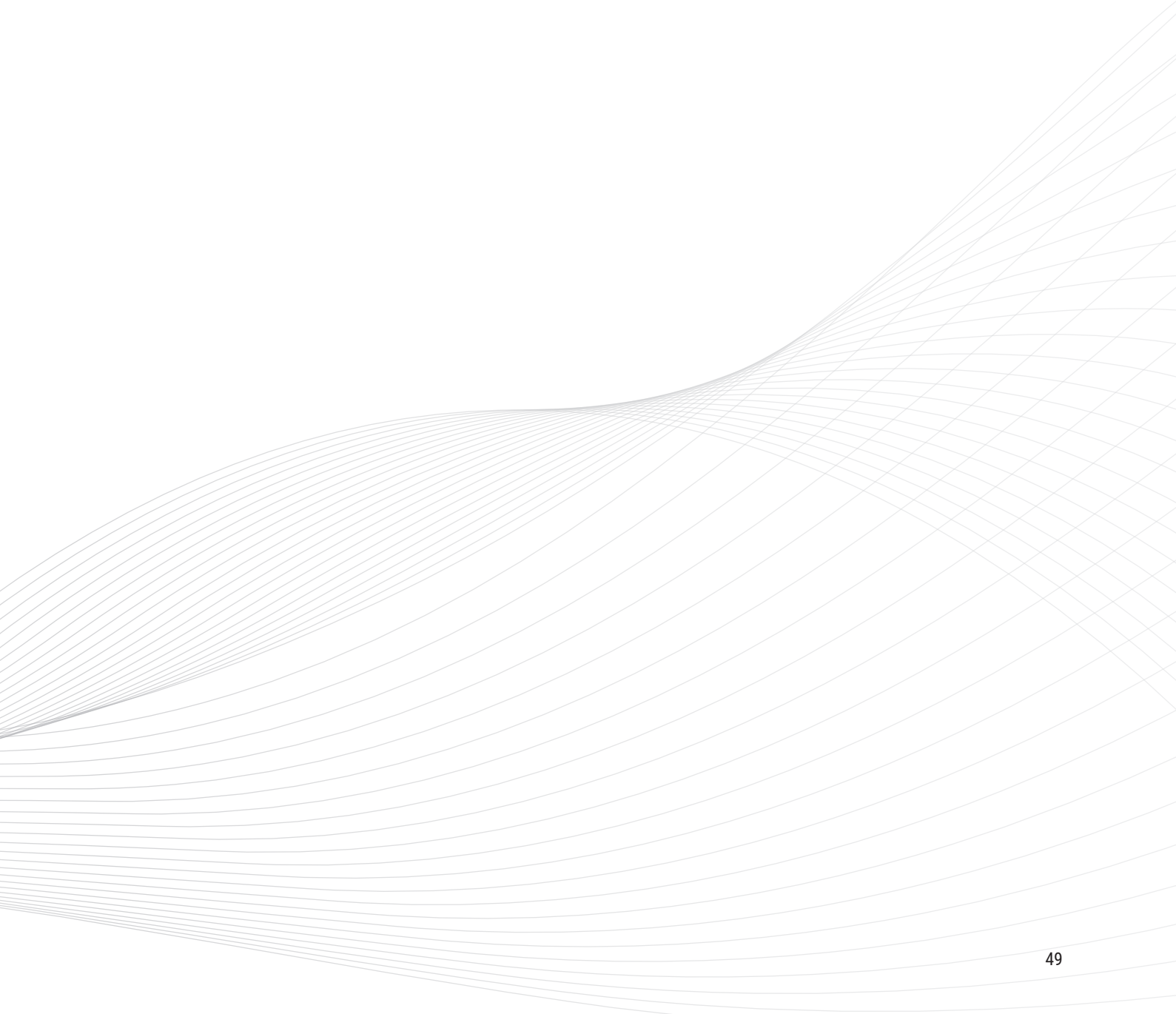

Notes

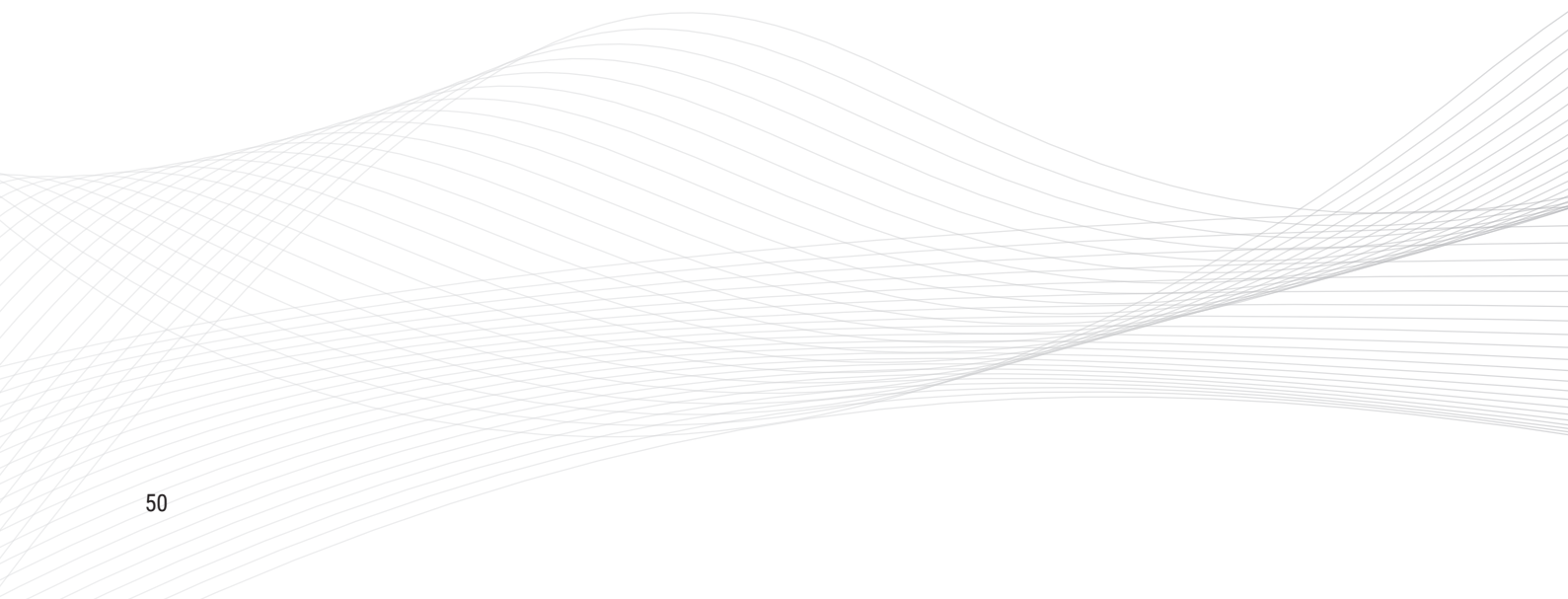



Rohmann GmbH

Carl-Benz-Str. 23
67227 Frankenthal
GERMANY

www.rohmann.de



Rohmann LLC

151 Corporate Drive
Suite H
Spartanburg, SC 29303
Tel: +1-864-208-0480
Fax: +1 864-208-0484
info@rohmann.com
www.rohmann.com